

# Wilson & Bradley L&S LED Lighting



[www.wilbrad.com.au](http://www.wilbrad.com.au)

**WILSON &  
BRADLEY**

SERVICE & CIVILITY

# INTRODUCTION TO LED LIGHTING



L & S is an Italian Company set up in 1977 in Maron di Brugnera, Italy.

Since their inception they have grown to become a leader in the LED lighting sector in both Italy and across the globe due to their advanced technical knowledge, stringent quality control and mission to always bring new and innovative products to the market.

Wilson & Bradley are proud to be the Australian distributor of L & S Lighting as the brand perfectly fits with their values and goals of delivering high quality products with exceptional after sales support and service.

## THE ADVANTAGE OF LED

LEDs have become the leader in lighting technology due to a number of advantages and enrich any kitchen's décor

- LEDs produce the entire range of visible light without harmful UV
- Filters are not necessary as in traditional lamps meaning L & S are free to choose the perfect tone and contrast of the lamp
- Sustainability- LEDs have a minimal impact on the environment and don't contain the harmful toxins that other traditional lamps often contain
- LEDs fixtures are more efficient than other traditional lamps, consuming 90% less than incandescent. Meaning both energy and cost savings
- The applications for LEDs are endless
- The long life span of LEDs means further cost savings
- Durability- LEDs are extremely durable and built with sturdy components
- Unlike traditional lights, LEDs can be switched on and off frequently without affecting the lifetime of the light and they brighten immediately when turned on

## ICON KEY

Throughout this booklet you will see a number of icons which depict certain helpful information and specifications on each product.

12VDC

Indicates voltage



Indicates number of LEDs per light

LED NO.



Indicates length of LED light

Dimension



Indicates Hole Dimension needed to recess LED light

Hole Dimension



Indicates wattage of LED

Wattage



Indicates the LED Light is part of the emotion range and comes with variable colour technology, ability to change light contrast from cool to warm and dim light with 3 step dimmer  
Emotion LED lights must be used in conjunction with either the Emotion dimmer (LSDIMMER) or Emotion remote (LSREMOTE)



IR Sensor is integrated into the lamp with a touchless function ON/OFF



IR Sensor is integrated into the lamp with the following function  
Door Open-ON / Door Close-OFF



PIR Sensor is integrated or applied separately and can manage multiple lamps. Lamps are connected to corresponding driver with distributor





# Standard LED Lighting Range



# SUNNY LS

## STANDARD LIGHTS what you require



**Standard Lights** –  
Your required quantity



**Driver Unit** – Either 30W (LSDRIVS30) or 75W (LSDRIVS75) depending on the combined wattage of the lights

Ordering L & S Lighting just got easier!  
Easy to order kits online now.



12VDC

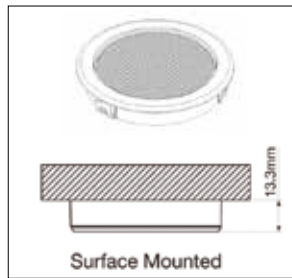
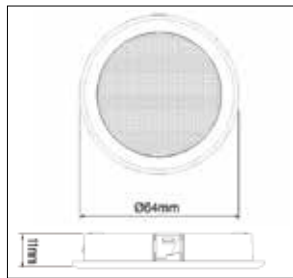

### SUNNY LS

- Can be recessed or surfaced mounted
- Available in white or nickel finish

CODE	CONTRAST	FINISH
LSSUNRC09	COOL	White
LSSUNRW09	WARM	White
LSSUNRC20	COOL	Nickel
LSSUNRW20	WARM	Nickel

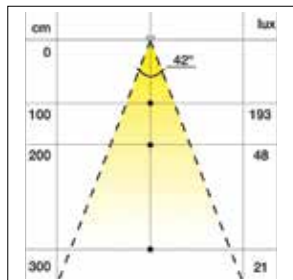

Hole Dimension	<b>58mm</b>	LED NO.	<b>15 LEDs</b>
Dimension	<b>64mm</b>	Wattage	<b>1.5W</b>



# SUNNY HE – SURFACE MOUNT

## STANDARD LIGHTS What you require



**Standard Lights –**  
Your required quantity



**Driver Unit –** Either 30W (LSDRIVS30) or 75W (LSDRIVS75) depending on the combined wattage of the lights



**Ordering L & S Lighting just got easier!**  
Easy to order kits online now.

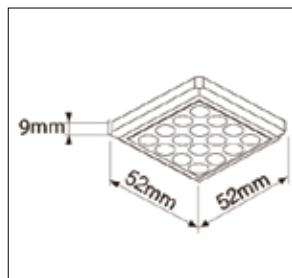
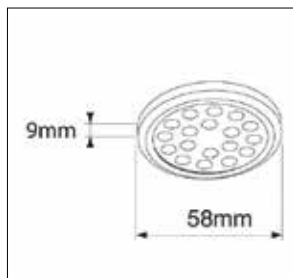

## SUNNY HE – Surface Mount 12VDC

- Surface mounted
- Available in stainless steel look or chrome look
- Available in round or square

### ROUND

CODE	CONTRAST	FINISH
LSSUNRC21	COOL	Chrome Look
LSSUNRW21	WARM	Chrome Look
LSSUNRC27	COOL	Stainless Steel Look
LSSUNRW27	WARM	Stainless Steel Look

### SQUARE

CODE	CONTRAST	FINISH
LSSUNSC21	COOL	Chrome Look
LSSUNSW21	WARM	Chrome Look
LSSUNSC27	COOL	Stainless Steel Look
LSSUNSW27	WARM	Stainless Steel Look

Hole Dimension	<b>58mm (round)</b>	LED NO.	<b>18 LEDs</b>
Hole Dimension	<b>52mm x 52mm (square)</b>	Wattage	<b>1.2W</b>



# PANLIGHT

## STANDARD LIGHTS what you require



**Standard Lights** –  
Your required quantity



**Driver Unit** – Either 30W (LSDRIVS30)  
or 75W (LSDRIVS75) depending on the  
combined wattage of the lights



**Ordering L & S Lighting just got easier!**  
Easy to order kits online now.

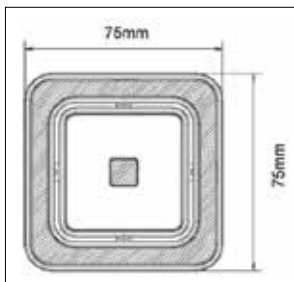
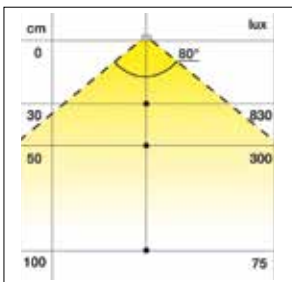
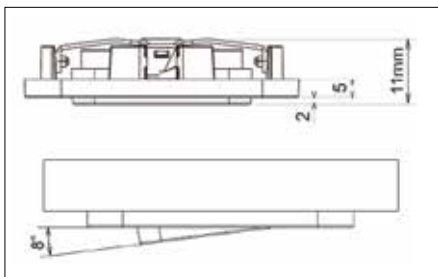

12VDC

## PANLIGHT

- Adjustable LED light with frosted diffuser for a soft light effect
- Available in white or black finish

CODE	CONTRAST	FINISH
LSPANC09	COOL WHITE	White
LSPANC04	COOL WHITE	Black

Hole Dimension	<b>68mm</b>	LED NO.	<b>30 LEDs</b>
Dimension	<b>75mm x 75mm</b>	Wattage	<b>3W</b>



## STANDARD LIGHTS what you require



**Standard Lights** –  
Your required quantity



**Driver Unit** – Either 30W (LSDRIVS30) or 75W (LSDRIVS75) depending on the combined wattage of the lights



12VDC

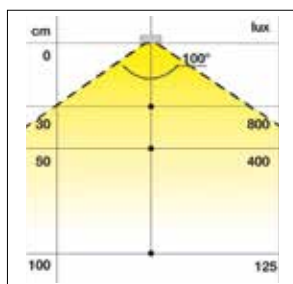
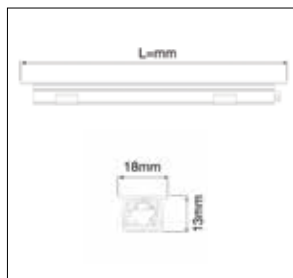

### MALINDI

- Recessed high efficiency LED lamp
- Equipped with frosted diffuser for a soft light effect
- Anodised aluminium finish

#### CODE

CODE	Dimension
LSMALC3	372mm
LSMALC5	500mm
LSMALC7	760mm
LSMALC1	1000mm

#### CONTRAST

CONTRAST	LED NO.	Wattage
COOL WHITE	48	5W
COOL WHITE	69	7W
COOL WHITE	111	11.5W
COOL WHITE	147	15W

\*Also available as a TOUCH light- turn to page 33



## STANDARD LIGHTS what you require



**Standard Lights** –  
Your required quantity



**Driver Unit** – Either 30W (LSDRIVS30)  
or 75W (LSDRIVS75) depending on the  
combined wattage of the lights



**Ordering L & S Lighting just got easier!**  
Easy to order kits online now.

12VDC

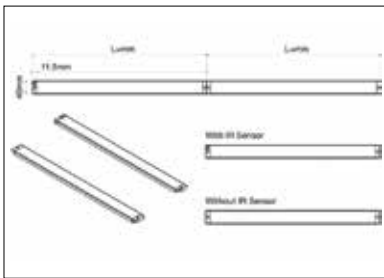

### LUMI

- Easy to install screw fixing
- Anodised aluminium finish

**CODE**  
LSLUMC3  
LSLUMC5



**Dimension**  
370mm  
520mm

**CONTRAST**  
COOL WHITE  
COOL WHITE

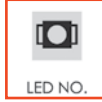

**LED NO.**  
36  
51



**Wattage**  
4W  
5.5W

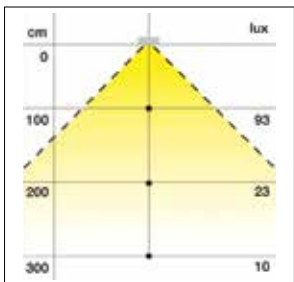

\*Also available as a SENSOR light- turn to page 16





## STANDARD LIGHTS what you require



**Standard Lights** –  
Your required quantity



**Driver Unit** – Either 30W (LSDRIVS30) or 75W (LSDRIVS75) depending on the combined wattage of the lights



Ordering L & S Lighting just got easier!  
Easy to order kits online now.

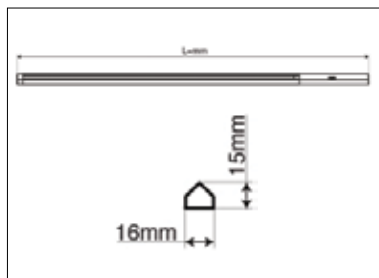

### AIR-UC

- Uniform under cabinet lighting
- The light output in the unit guarantees a complete and equal illumination of the work space
- Easy fixing surface mount with plastic bracket
- Anodised aluminium finish

12VDC

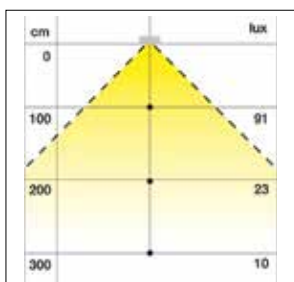

#### CODE

LSAIRC4	450mm
LSAIRC6	600mm
LSAIRC9	900mm
LSAIRC1	1200mm



Dimension

#### CONTRAST

COOL WHITE
COOL WHITE
COOL WHITE
COOL WHITE

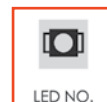

LED NO.



Wattage

66	6.8W
90	9.4W
135	14.3W
183	19W

\*Also available as a SENSOR light- turn to page 17



# FLY GLASS LIGHT

## FLY GLASS LIGHTS What you require



**Fly Glass Light** –  
Your required quantity



**Driver Unit** – Either 30W (LSDRIVS30)  
or 75W (LSDRIVS75) depending on  
the combined wattage of the lights



**6-8mm Thick Glass** –  
Can be fixed to 6-8mm  
thick glass



12VDC

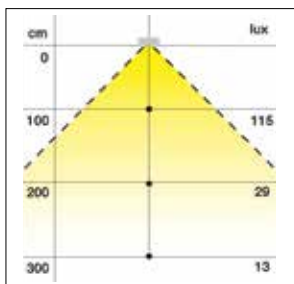

## FLY GLASS LIGHT

- Aluminium profile with LED bars
- Can be fixed to glass 6-8mm in thickness

### CODE

CODE	Dimension
LSFLYN4	412mm
LSFLYN5	562mm
LSFLYN8	862mm
LSFLYN1	1162mm



### CONTRAST

CONTRAST	LED NO.	Wattage
Nature White	16	1.4W
Nature White	21	1.9W
Nature White	32	2.9W
Nature White	42	3.8W

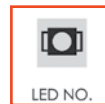



# Sensor LED Lighting Range



View website for full installation instructions & videos at [www.wilbrad.com.au](http://www.wilbrad.com.au)



# MIAMI IR SENSOR

## SENSOR LIGHTS What you require



**Sensor Lights** –  
Your required quantity



**Driver Unit** – Either 30W (LSDRIVS30)  
or 75W (LSDRIVS75) depending on the  
combined wattage of the lights



Ordering L & S Lighting just got easier!  
Easy to order kits online now.

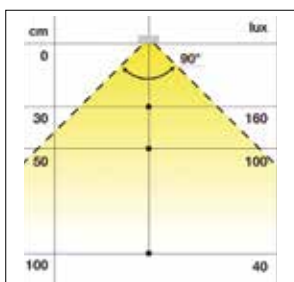
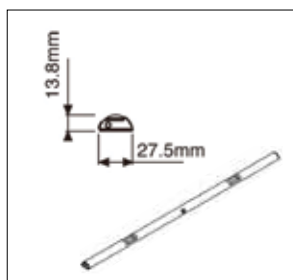

IR SENSOR (DOOR SENSOR SWITCH) 12VDC

## MIAMI IR SENSOR

- Spot illuminated drawer or cabinet light
- Integrated infrared sensor switches the light automatically on and off when drawer/door is opened or closed
- Easy fixing surface mount with plastic bracket
- Anodised aluminium finish

### CODE

CODE	Dimension
LSMIAIRC4	413mm
LSMIAIRC5	563mm
LSMIAIRC6	663mm
LSMIAIRC7	763mm
LSMIAIRC8	863mm
LSMIAIRC9	963mm
LSMIAIRC1	1163mm

### CONTRAST

COOL WHITE
COOL WHITE
COOL WHITE
COOL WHITE
COOL WHITE
COOL WHITE
COOL WHITE



LED NO.	Wattage
6	2W
6	2W
6	2W
12	4W
12	4W
12	4W
12	4W



## SENSOR LIGHTS What you require



**Sensor Lights** –  
Your required quantity



**Driver Unit** – Either 30W (LSDRIVS30) or 75W (LSDRIVS75) depending on the combined wattage of the lights



**Ordering L & S Lighting just got easier!  
Easy to order kits online now.**

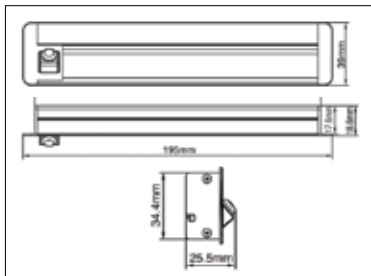

### CAPRI IR SENSOR

PIR SENSOR (MOTION DETECTOR) 12VDC

- Aluminium recessed high-efficiency LED lamp with integrated motion sensor
- Shape of light allows for a better spread of light
- Ideal for use inside cabinets
- Anodised aluminium finish

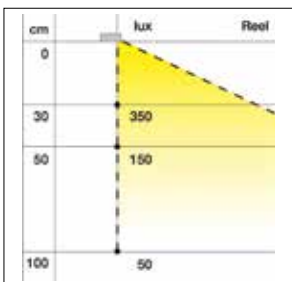

#### CODE

LSCAIRC19  
LSCAIRC5



195mm  
595mm

#### CONTRAST

COOL WHITE  
COOL WHITE

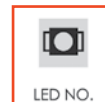

24  
72



2.4W  
8.7W



# FREE IR SENSOR

## SENSOR LIGHTS What you require

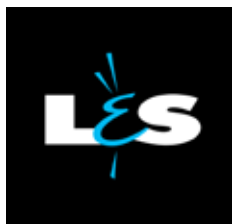

**Sensor Lights** –  
Your required quantity



**Driver Unit** – Either 30W (LSDRIVS30)  
or 75W (LSDRIVS75) depending on the  
combined wattage of the lights



**Ordering L & S Lighting just got easier!**  
Easy to order kits online now.

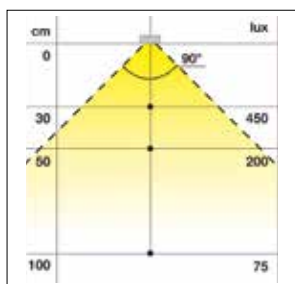
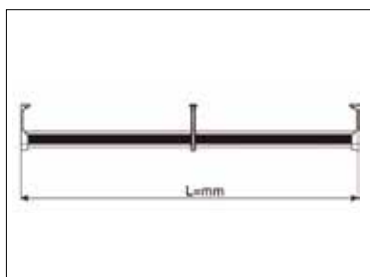

PIR SENSOR (MOTION DETECTOR) 12VDC

### FREE IR SENSOR

- Combined wardrobe hanging rail with high efficiency LED lighting
- Anodised aluminium finish
- Must use MINI MOTION SENSOR if using as a sensor light

	Dimension	CONTRAST	LED NO.	Wattage
CODE				
LSFREC5	540mm	COOL WHITE	36	4W
LSFREC7	750mm	COOL WHITE	51	5.5W
LSFREC8	870mm	COOL WHITE	57	6W
LSFREC1	1050mm	COOL WHITE	72	7.5W

### IR MINI MOTION SENSOR ACCESSORY

- Maximum Sensor detection distance of 2.5 metres

CODE  
LSFRESEN

MINI MOTION SENSOR  
(MAX SENSOR DETECTION 2.5m)



## SENSOR LIGHTS What you require



**Sensor Lights** –  
Your required quantity



**Driver Unit** – Either 30W (LSDRIVS30)  
or 75W (LSDRIVS75) depending on the  
combined wattage of the lights



**Ordering L & S Lighting just got easier!**  
Easy to order kits online now.

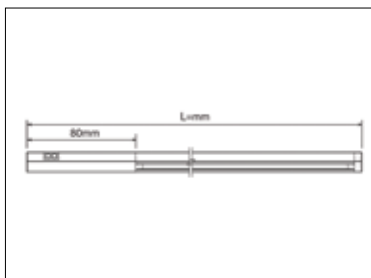
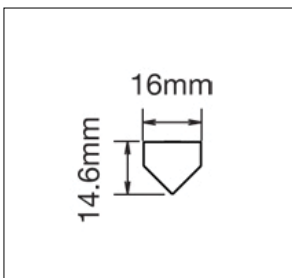

### AIR- C IR SENSOR

IR SENSOR  
(DOOR SENSOR SWITCH) 12VDC

- Provides powerful illumination for drawers
- Intergrated IR switch, turns light on and off when the drawer is opened and closed
- Easy installation with plastic fitting bracket
- Anodised aluminium finish

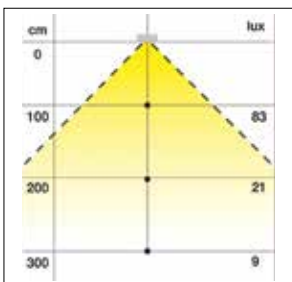

CODE	Dimension
LSARIRD4	413mm
LSARIRD5	563mm
LSARIRD8	863mm
LSARIRD1	1163mm

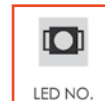

CONTRAST	LED NO.	Wattage
COOL WHITE	45	4.5W
COOL WHITE	69	7W
COOL WHITE	114	12W
COOL WHITE	162	16.5W



# LUMI IR SENSOR

## SENSOR LIGHTS What you require



**Sensor Lights** –  
Your required quantity



**Driver Unit** – Either 30W (LSDRIVS30)  
or 75W (LSDRIVS75) depending on the  
combined wattage of the lights



**Ordering L & S Lighting just got easier!**  
Easy to order kits online now.

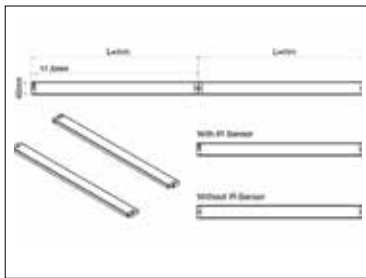

### LUMI IR SENSOR

- Integrated sensor switch
- Easy to install screw fixing
- Anodised aluminium finish

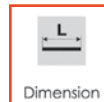
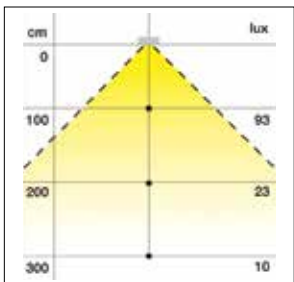
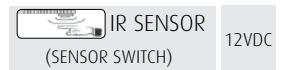

CODE	Dimension
LSLUMIRC3	370mm
LSLUMIRC5	520mm

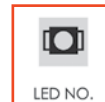

CONTRAST	LED NO.
COOL WHITE	33
COOL WHITE	51



Wattage
3.6W
5.1W

Also available as a STANDARD light- turn to page 8.





## SENSOR LIGHTS What you require



**Sensor Lights –**  
Your required quantity



**Driver Unit –** Either 30W (LSDRIVS30) or 75W (LSDRIVS75) depending on the combined wattage of the lights



Ordering L & S Lighting just got easier!  
Easy to order kits online now.

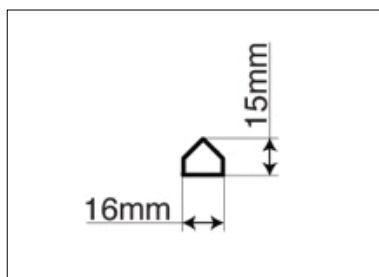
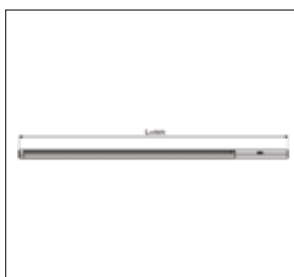

### AIR- UC IR SENSOR

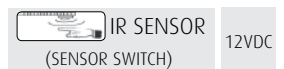

- Integrated infrared sensor switches the light on and off
- Uniform under cabinet lighting
- The light output in the unit guarantees a complete and equal illumination of the work space
- Easy fixing surface mount with plastic bracket
- Anodised aluminium finish
- Must only be used with 30W driver unit

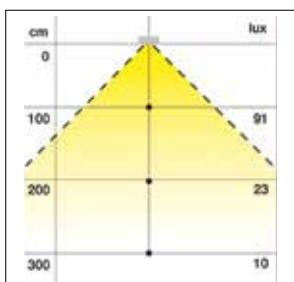

Dimension

CODE	Dimension
LSARIRC4	450mm
LSARIRC6	600mm
LSARIRC9	900mm
LSARIRC1	1200mm

### CONTRAST

COOL WHITE
COOL WHITE
COOL WHITE
COOL WHITE

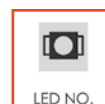

LED NO.



Wattage

51	5.5W
75	8.2W
120	13W
168	18.2W

Also available as a STANDARD light- turn to page 9.





# Emotion LED Lighting Range



The emotion range is the next level in LED technology. The LEDs in the Emotion range come with variable colour technology, which is the ability to change the light contrast from cool to warm. All emotion lights must be used in conjunction with either the Emotion Remote or Emotion Dimmer which also allow the lights to be dimmed.

## EMOTION DIMMER & REMOTE



- Either a dimmer or remote is required for use of all emotion lighting
- Both units contain a 3 step dimmer, an on/off switch and a variable colour technology to change lights from warm to cool contrast

**DIMMER**  
**CODE**  
LSDIMMER



**REMOTE**  
**CODE**  
LSREMOTE



## EMOTION LIGHTS What you require

L&S



**Emotion Lights** –  
Your required quantity

+



**Driver Unit** – 30W driver  
only (LSDRIVS30)

+



**Emotion Control** – Either  
Emotion Dimmer (LSDIMMER) or  
Emotion Remote (LSREMOTE)

\* Please note only one style of Emotion light per transformer is to be used

**Ordering L & S Lighting just got easier!**  
Easy to order kits online now.

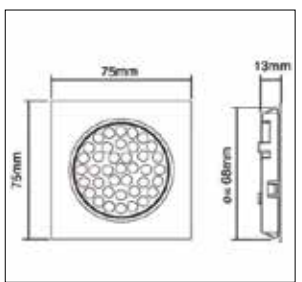
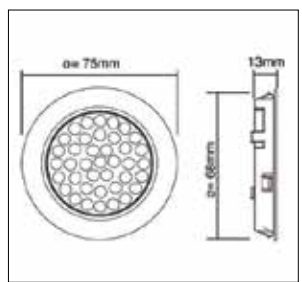

### NOVA EMOTION

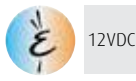





- Extra slim recessed lighting
- Emotion technology allows light to be adjusted from warm white to cool white
- Must be used in conjunction with either L & S dimmer or remote
- Small installation depth of 13mm
- Available in round or square
- Available in brushed stainless or chrome look

#### ROUND

<b>CODE</b>	<b>FINISH</b>
LSNVEM21	Chrome Look
LSNVEM27	Stainless Steel Look

#### SQUARE

<b>CODE</b>	<b>FINISH</b>
LSNVSEM21	Chrome Look
LSNVSEM27	Stainless Steel Look

	<b>68mm</b>		<b>39 LEDs</b>
Hole Dimension		LED NO.	
	<b>75mm</b>		<b>2.7W</b>
Dimension		Wattage	



# SUPERLIGHT EMOTION

## EMOTION LIGHTS what you require

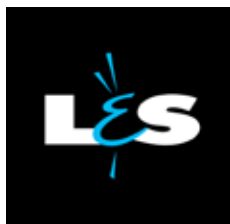

**Emotion Lights** –  
Your required quantity



**Driver Unit** – 30W driver  
only (LSDRIVS30)



**Emotion Control** – Either  
Emotion Dimmer (LSDIMMER) or  
Emotion Remote (LSREMOTE)

\* Please note only one style of Emotion light per transformer is to be used

Ordering L & S Lighting just got easier!  
Easy to order kits online now.

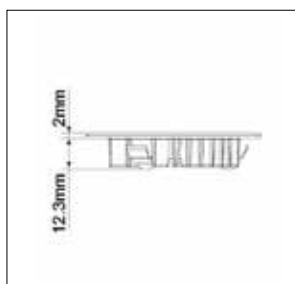
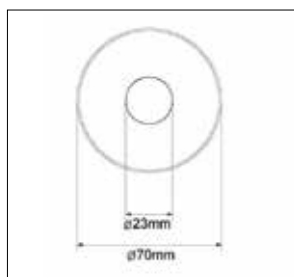

	<b>58mm</b>		<b>9 LEDs</b>
Hole Dimension		LED NO.	
	<b>70mm</b>		<b>2.9W</b>
Dimension		Wattage	

## SUPERLIGHT EMOTION



12VDC

- Recessed uniquely designed Spotlight
- High quality aluminium housing
- Emotion technology allows light to be adjusted from warm white to cool white
- Must be used in conjunction with either L & S dimmer or remote
- Available in white or brushed steel look
- Must only be used with 30W driver unit

### CODE

LSSUPEM09

LSSUPEM27

### FINISH

White

Brushed Steel Look



# MOONLIGHT EMOTION

## EMOTION LIGHTS What you require



**Emotion Lights** –  
Your required quantity



**Driver Unit** – 30W driver  
only (LSDRIVS30)



**Emotion Control** – Either  
Emotion Dimmer (LSDIMMER) or  
Emotion Remote (LSREMOTE)

\* Please note only one style of Emotion light per transformer is to be used

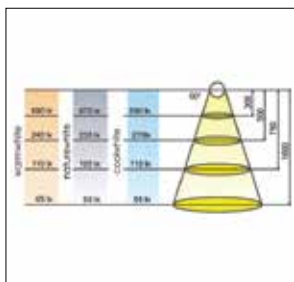
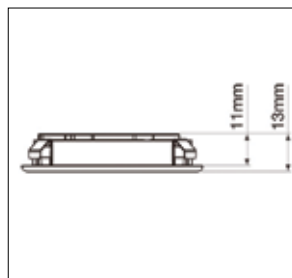
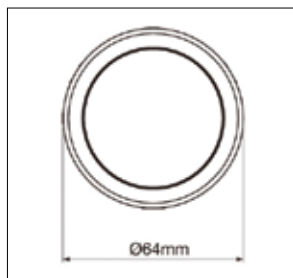

	<b>58mm</b>		<b>30 LEDs</b>
Hole Dimension		LED NO.	
	<b>64mm</b>		<b>3W</b>
Dimension		Wattage	

## MOONLIGHT EMOTION



12VDC

- Recessed LED spotlight with frosted diffuser for soft and uniform light effect
- Emotion technology allows light to be adjusted from warm white to cool white
- Must be used in conjunction with either L & S dimmer or remote
- Small installation depth of 13.3mm
- Available in white or nickel
- Must only be used with 30W driver unit

### ROUND

#### CODE FINISH

LSMOOEM09 White  
LSMOOEM20 Nickel



# LED II EMOTION

## EMOTION LIGHTS what you require



**Emotion Lights** – Your required quantity



**Driver Unit** – 30W driver only (LSDRIVS30)



**Emotion Control** – Either Emotion Dimmer (LSDIMMER) or Emotion Remote (LSREMOTE)

\* Please note only one style of Emotion light per transformer is to be used



**Ordering L & S Lighting just got easier!**  
Easy to order kits online now.

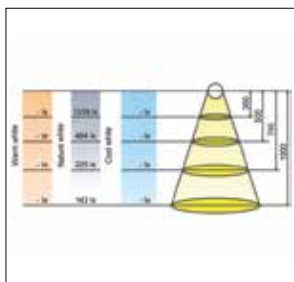
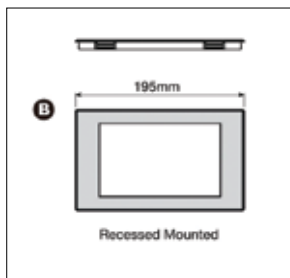
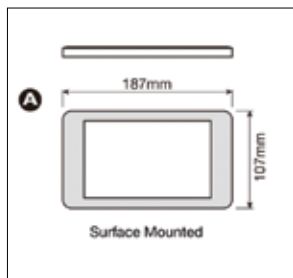

Hole Dimension	<b>58mm</b>
LED NO.	<b>60 LEDs</b>
Wattage	<b>5.5W</b>

### LED II EMOTION



- Available in a recessed or surface mount version
- Emotion technology allows light to be adjusted from warm white to cool white
- Must be used in conjunction with either L & S dimmer or remote
- Small installation depth of 12mm for recessed version
- Integrated LED panel has even illumination
- Available in white or nickel finish
- Must only be used with 30W driver unit

#### RECESSED APPLICATION

CODE	FINISH
LSIIE09R	White
LSIIE20R	Nickel

#### SURFACE MOUNT APPLICATION

CODE	FINISH
LSIIE09S	White
LSIIE20S	Nickel



## EMOTION LIGHTS What you require



**Emotion Lights** –  
Your required quantity



**Driver Unit** – 30W driver  
only (LSDRIVS30)



**Emotion Control** – Either  
Emotion Dimmer (LSDIMMER) or  
Emotion Remote (LSREMOTE)

\* Please note only one style of Emotion light per transformer is to be used



Ordering L & S Lighting just got easier!  
Easy to order kits online now.

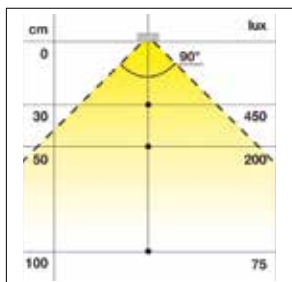
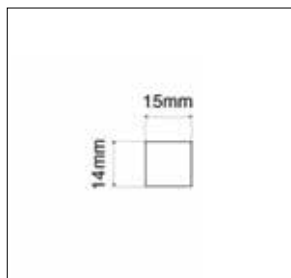
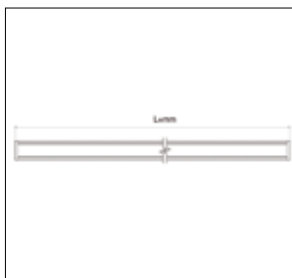



## BALI EVO EMOTION



12VDC

- Surface mounted profile
- EVO frosted diffuser for a soft light effect
- Emotion technology allows light to be adjusted from warm white to cool white
- Must be used in conjunction with either L & S dimmer or remote
- Quick connector and extension cable included
- Anodised aluminium finish
- Must only be used with 30W driver unit

### CODE

	 Dimension	 LED NO.	 Wattage
LSBALIEM4	450mm	63	6.3W
LSBALIEM6	600mm	87	8.7W
LSBALIEM9	900mm	135	13.5W
LSBALIEM1	1200mm	180	18W



# DERBY EVO EMOTION

## EMOTION LIGHTS what you require



**Emotion Lights** –  
Your required quantity



**Driver Unit** – 30W driver  
only (LSDRIVS30)



**Emotion Control** – Either  
Emotion Dimmer (LSDIMMER) or  
Emotion Remote (LSREMOTE)

\* Please note only one style of Emotion light per transformer is to be used



**Ordering L & S Lighting just got easier!**  
Easy to order kits online now.

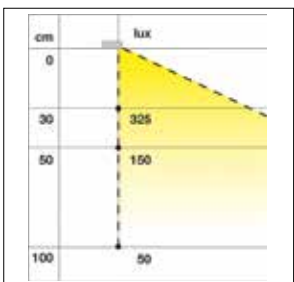
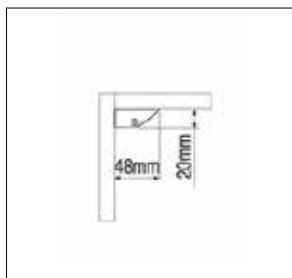

## DERBY EVO EMOTION



- Surface mounted profile
- EVO frosted diffuser for a soft light effect
- Emotion technology allows light to be adjusted from warm white to cool white
- Must be used in conjunction with either L & S dimmer or remote
- Easy install with plastic bracket
- Anodised aluminium finish
- Ideal for wall unit applications
- Must only be used with 30W driver unit

### CODE

	Dimension	LED NO.	Wattage
LSDEREM4	450mm	66	7W
LSDEREM6	600mm	90	9W
LSDEREM9	900mm	138	14W
LSDEREM1	1200mm	183	19W

L	W
Dimension	Wattage





## EMOTION LIGHTS What you require



**Emotion Lights** –  
Your required quantity



**Driver Unit** – 30W driver  
only (LSDRIVS30)



**Emotion Control** – Either  
Emotion Dimmer (LSDIMMER) or  
Emotion Remote (LSREMOTE)

\* Please note only one style of Emotion light per transformer is to be used

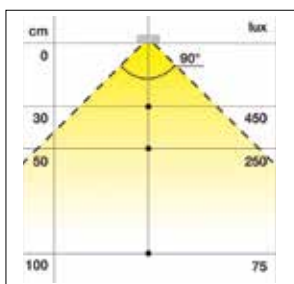
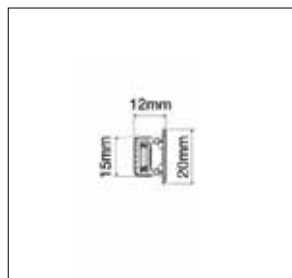
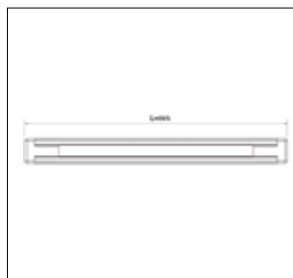



## MANILA EVO EMOTION



12VDC

- Recessed aluminium light fitting
- EVO frosted diffuser for a soft light effect
- Emotion technology allows light to be adjusted from warm white to cool white
- Must be used in conjunction with either L & S dimmer or remote
- Small installation depth of 12mm
- Anodised aluminium finish
- Must only be used with 30W driver unit

### CODE

	 Dimension	 LED NO.	 Wattage
LSMANEM3	372mm	48	5.2W
LSMANEM5	500mm	69	7.5W
LSMANEM7	760mm	108	11.7W
LSMANEM1	1000mm	147	15.9W





# Strip LED Lighting Range



# STRIP LED PLUS

## STRIP LED PLUS what you require



**Strip LED Plus Light** –  
Your required length and  
quantity



**Driver Unit** – Either 30W (LSDRIVS30)  
or 75W (LSDRIVS75) depending on  
the combined wattage of the lights



**Connection Cord** –  
OPTIONAL if connecting two  
Strip LED together



**Soft Link** – Connects  
light to driver unit



Ordering L & S Lighting just got easier!  
Easy to order kits online now.

## STRIP LED PLUS

- Module strip with high efficiency LEDs
- Connection cord required to be purchased separately to connect light to driver unit
- Soft link accessory optional if wanting to connect two STRIP LED PLUS together

CODE	 Dimension	CONTRAST	 LED NO.	 Wattage
LSSTRIP84	84mm	COOL WHITE	3	0.7W
LSSTRIP25	250mm	COOL WHITE	9	2W

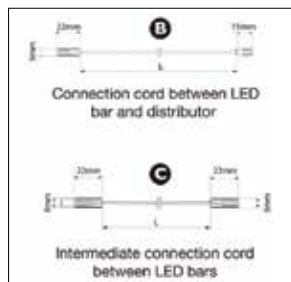
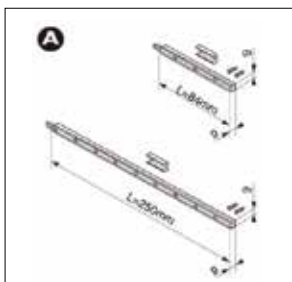

## REQUIRED ACCESSORIES

### CONNECTION CORD

- Connects LED Strip Light to Driver Unit

### CODE

LSSTRCON2      2000mm



12VDC

## OPTIONAL ACCESSORIES

### SOFT LINK

- Use to connect two STRIP LED PLUS lengths together
- Designed to minimise dark spots between each connection

### CODE

LSSTRSL3      30mm  
LSSTRSL15      1500mm  
LSSTRSL30      300mm



# STRIP LED REEL

## STRIP LIGHTS what you require





**Strip LED Reel** –  
5 METRE (LSSTREEL)

+



**Connection Cord** – used for  
connecting Strip LED to driver.  
1 required per driver (LSTRECON2)

+



**Soft Link or Bridge Connector** –  
Required if connecting two pieces  
of strip lighting together

+





**Driver Unit** – 75W driver  
only (LSDRIVS75)



Ordering L & S Lighting just got easier!  
Easy to order kits online now.

### STRIP LED REEL

- Flexible strip LED
- Supplied in 5 metre roll
- Strip can be cut at predefined distance of 28mm every 3PCs of LEDs
- Supplied with double sided tape on back of strip for quick application
- Strip Connector required to be bought separately to connect to driver unit
- Soft link accessory optional if wanting to connect two pieces of STRIP LED REEL together

<b>CODE</b>	 Dimension	 LED NO.	 Wattage
LSSTREEL	5 metre reel	108 LED per metre	11.7W per meter

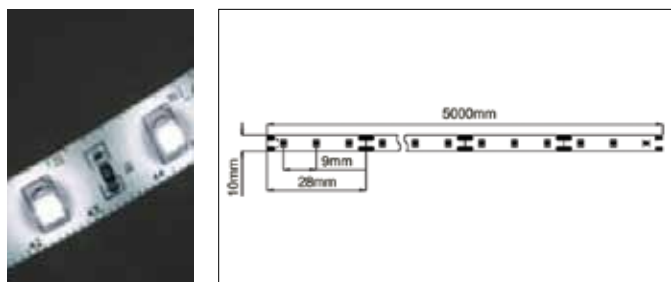

### REQUIRED ACCESSORIES

#### CONNECTION CORD

- Connects LED Strip Light to Driver Unit

<b>CODE</b>	 Dimension
LSSTRCON2	2000mm



### OPTIONAL ACCESSORIES

#### SOFT LINK

- Use to connect two STRIP LED PLUS lengths together
- Designed to minimise dark spots between each connection

<b>CODE</b>	 Dimension
LSSTRSL3	30mm
LSSTRSL30	300mm



#### BRIDGE CONNECTOR

<b>CODE</b>
LSTREBC

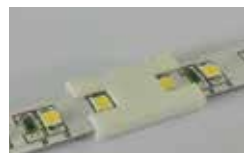

12VDC



## INSTALLATION VIDEOS NOW AVAILABLE FOR L & S LIGHTING



1. Head to the Wilson & Bradley Webpage:  
[www.wilbrad.com.au](http://www.wilbrad.com.au)



2. Go to Media Centre



3. Click on Instructional Videos and start viewing

[www.wilbrad.com.au](http://www.wilbrad.com.au)



# MALINDI MECCANO- Strip Reel with frosted diffuser

## STRIP LIGHTS what you require



**MALINDI MECCANO Strip Reel**  
(LSMAMREEL)



**+ Frosted Diffuser**  
(LSMAMFD3)

**+ Cord Grip**  
(OPTIONAL)

**+ Aluminium Profile**  
(LSMAMAP3)

**+ Soft Link**  
(OPTIONAL)

**+ LED Strip Base**  
(LSMAMB1)

**+ Fixing Bracket**  
(LSMAMFB)

**+ Connector Input**

**+ Driver Unit**  
(LSDRIVS30 or LSDRIVS75)

\* Please Note Reel can be cut at 42mm increments, every 3 LEDs



**Ordering L & S Lighting just got easier!  
Easy to order kits online now.**

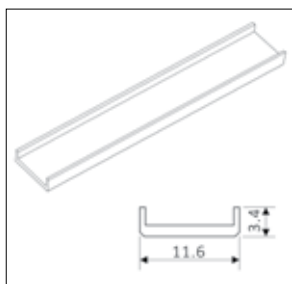

12VDC

### MALINDI MECCANO FLEXIBLE STRIP LED REEL

- Flexible strip LED Designed for use in Aluminium profile with frosted diffuser
- Supplied in 5 metre roll
- Strip can be cut at predefined distance of 28mm every 3PCs of LEDs
- Supplied with double sided tape on back of strip for quick application
- Soft link accessory optional if wanting to connect two pieces of STRIP LED REEL together
- Strip Connector required to be bought separately to connect to driver unit

#### CODE

LSMAMREEL



Dimension

5 metre reel

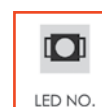

LED NO.

156 LED per metre



Wattage

16.9W per meter



# MALINDI MECCANO- Strip Reel with frosted diffuser

## ALUMINIUM PROFILE



**CODE**  
LSMAMAL3 3000mm

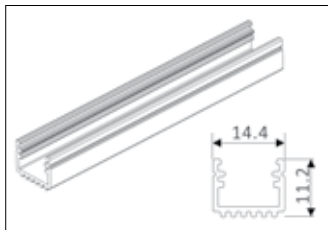

## LED STRIP BASE

- Allows for ease of installation
- Flexible LED Strip is fixed to strip base with adhesive then easily slid into Aluminium profile



**CODE**  
LSMAMB1 1500mm

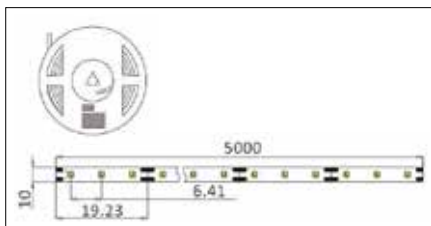

## CONNECTOR INPUT

- Connects LED Strip Light to Driver Unit



**CODE**  
LSSTRECON 3000mm



## FROSTED DIFFUSER

- Creates a consistent and even frosted lighting effect



**CODE**  
LSMAMFD3 3000mm

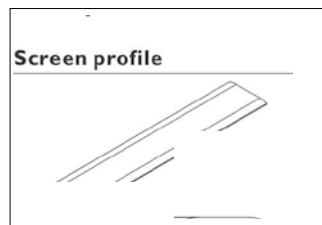

## FIXING BRACKET

- Fixes to Aluminium profile (LSMAMAL3) and ensures the aluminium profile is held in place in recessed hole

**CODE**  
LSMAMFB

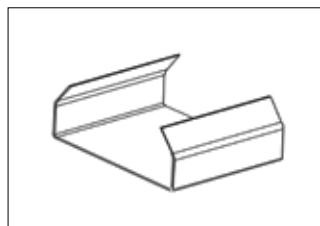

## CORD GRIP

- Neatly fixes and protects the input cable (LSSTRECON) to Aluminium Profile (LSMAMAL3)

**CODE**  
LSMAMCG

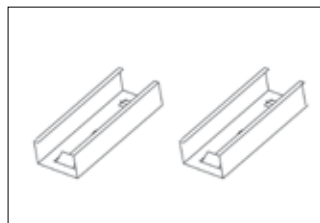

## OPTIONAL ACCESSORIES

### SOFT LINK

- Use to connect two pieces of MALINDI MECCANO STRIP LED REEL together



**CODE**  
LSMAMSL3 30mm  
LSMAMSL30 300mm

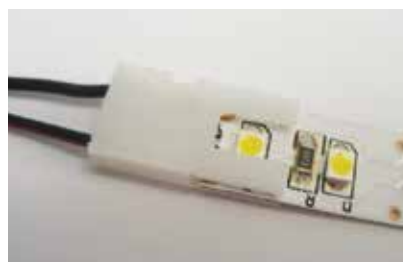

REQUIRED ACCESSORIES - MALINDI MECCANO





# Touch LED Lighting Range





## TOUCH LED LIGHTS What you require



**MALINDI TOUCH** –  
Your required length and  
quantity



**Driver Unit** – Either 30W (LSDRIVS30)  
or 75W (LSDRIVS75) depending on the  
combined wattage of the lights



Ordering L & S Lighting just got easier!  
Easy to order kits online now.

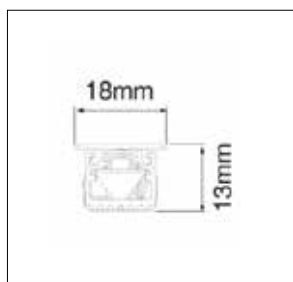
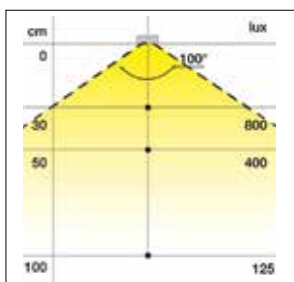

12VDC

## MALINDI TOUCH

- Recessed high efficiency LED lamp with integrated touch function
- Equipped with frosted diffuser for a soft light effect
- Plug and play system for toolless mounting
- Anodised aluminium finish

### CODE

CODE	Dimension
LSMALTOC3	352mm
LSMALTOC5	500mm
LSMALTOC7	760mm
LSMALTOC1	1000mm

### CONTRAST

COOL WHITE
COOL WHITE
COOL WHITE
COOL WHITE



LED NO.



Wattage

45	4.5W
66	7W
108	11W
144	14.5W

Also available as a STANDARD light- turn to page 7



# MALINDI MECCANO TOUCH - Strip Reel with frosted diffuser

## TOUCH LED LIGHTS What you require



**MALINDI MECCANO Strip Reel**  
(LSMAMREEL)



**+ Frosted Diffuser**  
(LSMAMFD3)

**+ Cord Grip**  
(OPTIONAL)

**+ Aluminium Profile**  
(LSMAMAP3)

**+ Soft Link**  
(OPTIONAL)

**+ LED Strip Base**  
(LSMAMB1)

**+ Fixing Bracket**  
(LSMAMFB)

**+ Connector Input**

**+ Driver Unit**  
(LSDRIVS30 or LSDRIVS75)

\* Please Note Reel can be cut at 42mm increments, every 3 LEDs

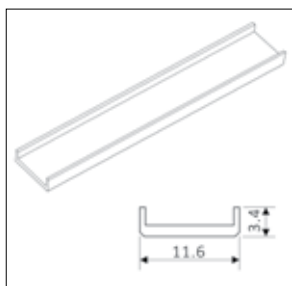

### MALINDI MECCANO TOUCH FLEXIBLE STRIP LED REEL

12VDC

- Flexible strip LED Designed for use in Aluminium profile with frosted diffuser
- Supplied in 5 metre roll
- Strip can be cut at predefined distance of 28mm every 3PCs of LEDs
- Supplied with double sided tape on back of strip for quick application
- Soft link accessory optional if wanting to connect two pieces of STRIP LED REEL together
- Strip Connector required to be bought separately to connect to driver unit

#### CODE

LSMAMREEL



Dimension

5 metre reel

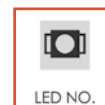

LED NO.

156 LED per metre



Wattage

16.9W per meter



# MALINDI MECCANO TOUCH - Strip Reel with frosted diffuser

## ALUMINIUM PROFILE

**CODE**  
LSMAMAL3 3000mm

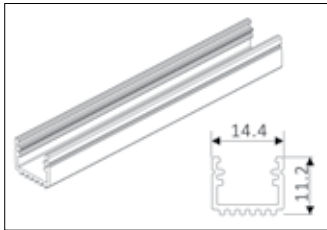
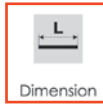

## LED STRIP BASE

- Allows for ease of installation
- Flexible LED Strip is fixed to strip base with adhesive then easily slid into Aluminium profile

**CODE**  
LSMAMB1 1500mm

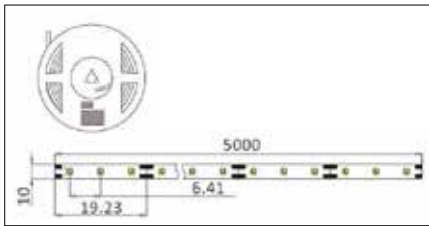
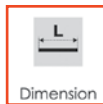

## TOUCH CONNECTOR INPUT

- Integrated touch function

**CODE**  
LSTRECONT 3000mm



## FROSTED DIFFUSER

- Creates a consistent and even frosted lighting effect

**CODE**  
LSMAMFD3 3000mm

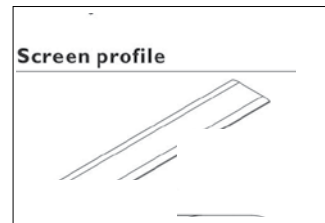

## FIXING BRACKET

- Fixes to Aluminium profile (LSMAMAL3) and ensures the aluminium profile is held in place in recessed hole

**CODE**  
LSMAMFB

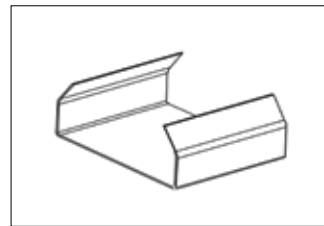

## CORD GRIP

- Neatly fixes and protects the input cable (LSSTRECON) to Aluminium Profile (LSMAMAL3)

**CODE**  
LSMAMCG

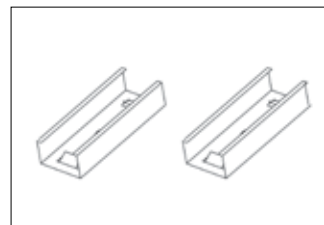

REQUIRED ACCESSORIES - MALINDI MECCANO TOUCH

## OPTIONAL ACCESSORIES

### SOFT LINK

- Use to connect two pieces of MALINDI MECCANO STRIP LED REEL together

**CODE**  
LSMAMSL3 30mm  
LSMAMSL30 300mm

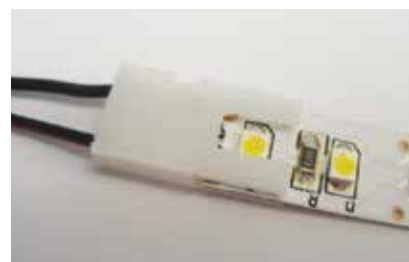

# TOKI BLUETOOTH SPEAKER AND CHARGER

The Toki Bluetooth Speaker & Charger is the must have accessory for any kitchen. Listen to music or your favourite pod cast whilst your cook or entertain in your kitchen or simply use it to charge any USB chargeable device. The Toki Speaker & Charger is perfect for under cabinet applications.



12VDC

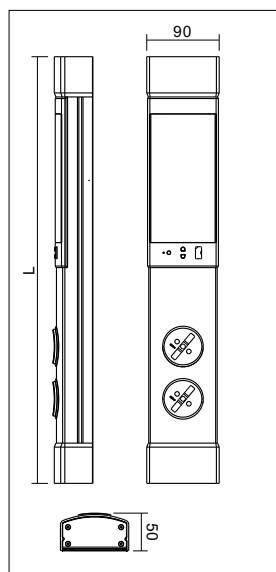
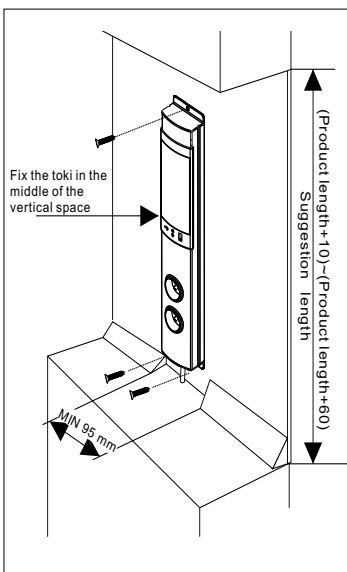

## TOKI BLUETOOTH SPEAKER AND CHARGER

- Connect any mobile device by either USB or Bluetooth
- Integrated Speaker
- USB port for charging devices
- Also includes 2 power sockets to power appliances
- Adjustable height of 540mm- 600mm
- Featuring Bluetooth technology allowing connection to mobile devices
- 220-240VDC
- 50/60Hz

**CODE**  
LSTOKI



# REMOTE CONTROLS AND SWITCHES

The emotion range is the next level in LED technology. The LEDs in the Emotion range come with variable colour technology, which is the ability to change the light contrast from cool to warm. All emotion lights must be used in conjunction with either the Emotion Remote or Emotion Dimmer which also allow the lights to be dimmed.



## EMOTION DIMMER & REMOTE

- Either a dimmer or remote is required for use of all emotion lighting
- Both units contain a 3 step dimmer, an on/off switch and a variable colour technology to change lights from warm to cool contrast

**REMOTE  
CODE**  
LSREMOTE



**DIMMER  
CODE**  
LSDIMMER



# REMOTE CONTROLS AND SWITCHES



## RADIO SWITCH

- Not compatible with Emotion range
- Remote on/off system
- The transmitter is battery powered. It has a built in sleep function to save
- Maximum Range of 15 metres
- Must purchase receiver and remote

### RECEIVER

- Includes 10 way distributor and 75W driver
- Max 3 receivers per remote

### Code

LSRADIOR

### REMOTE

- Max 9 remotes per receiver

### Code

LSRADIOS

## LED IR MOTION SENSOR AND SWITCH

- Compatible with all L & S LED lights
- Can be used as either a motion door sensor or a on/off switch
- Changes easily between functions with the flick of a switch
- Unique memory function ensures the unit will return to its previous function in case of a power outage
- Maximum Sensor detection distance of 2.5 metres

### IR MINI MOTION SENSOR

### CODE

LSMOSEN



## DRIVER UNITS & ACCESSORIES

### 75 WATT DRIVER UNIT

- Output Distributor & plug
- Use for lights with combined wattage up to 75 watts

#### CODE

LSDRIVS75

### 30 WATT DRIVER UNIT

- Output Distributor & plug
- Use for lights with combined wattage up to 30 watts
- 30 watt driver unit must be used with EMOTION lights & SENSOR lights

#### CODE

LSDRIVS30

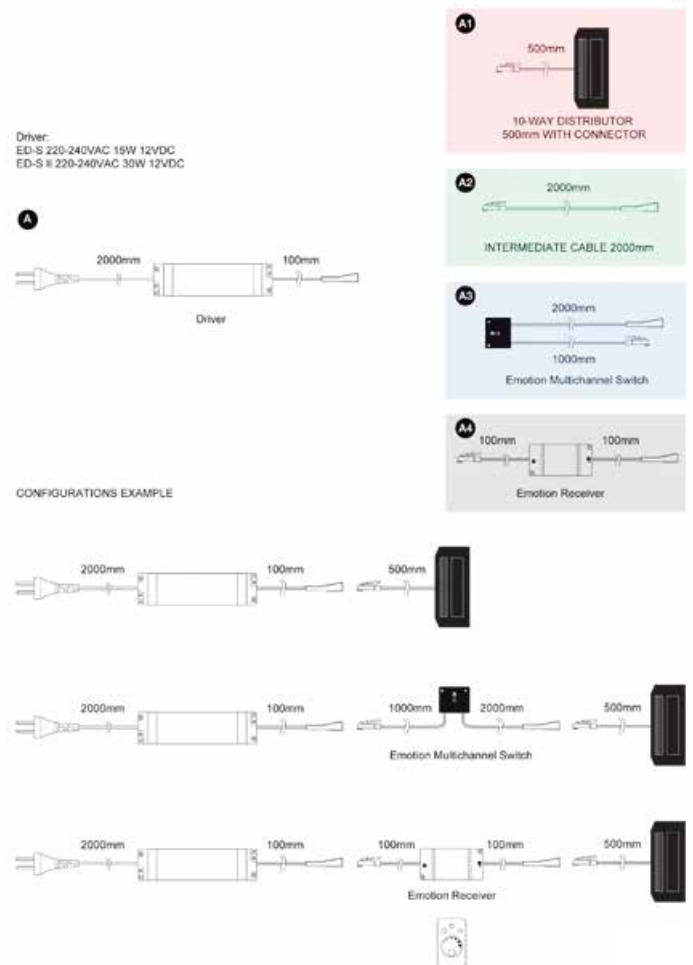
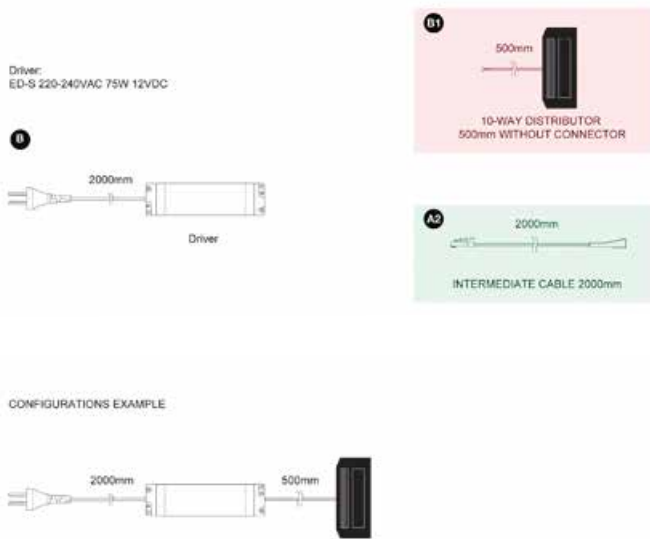

### LED EXTENSION CABLE

- Extends length between LED lights and distributor
- 500mm or 1000mm length

#### CODE

LSEXTENT 500mm  
LSEXTENT2 1000mm



### LED EXTENSION CABLE FOR DISTRIBUTOR

- Extends length between Driver unit & Distributor

#### CODE

LSEXTENB



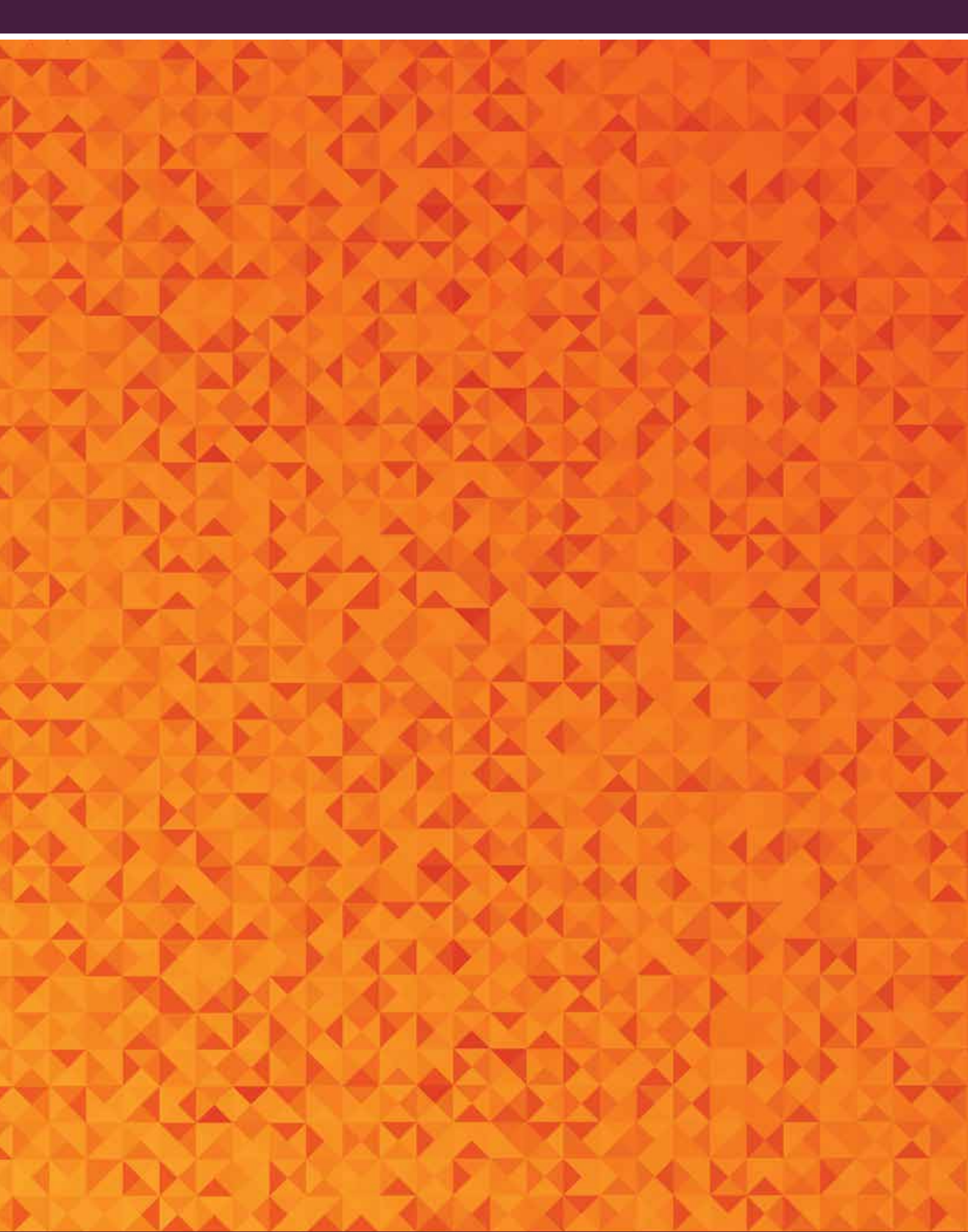

Quality  
ISO 9001

SAI GLOBAL

### Melbourne

94 Bell Street  
Preston VIC 3072  
P. 03 9495 8900  
F. 03 9416 8878

### Sydney

Unit4, 3 Basalt Road  
Greystanes NSW 2145  
P. 02 8863 2700  
F. 02 9636 8822

### Hobart

[sales@wilbrad.com.au](mailto:sales@wilbrad.com.au)

### Brisbane

2/60 Enterprise Place  
Tingalpa QLD 4173  
P. 07 3890 8611  
F. 07 3890 3375

### Perth

43 Prosperity Ave  
Wangara WA 6065  
P. 08 9303 2644  
F. 08 9303 9788

### Adelaide

41 Weaver Street  
Edwardstown SA 5039  
P. 08 8276 3800  
F. 08 8276 3755

